



SHOTTON PARMED

FORENSIC HOSPITAL PATHOLOGY LABORATORY
ANATOMY MORTUARY VETERINARY

AUSTRALIAN
OWNED &
MANUFACTURED

CLINICAL STORAGE & HANDLING



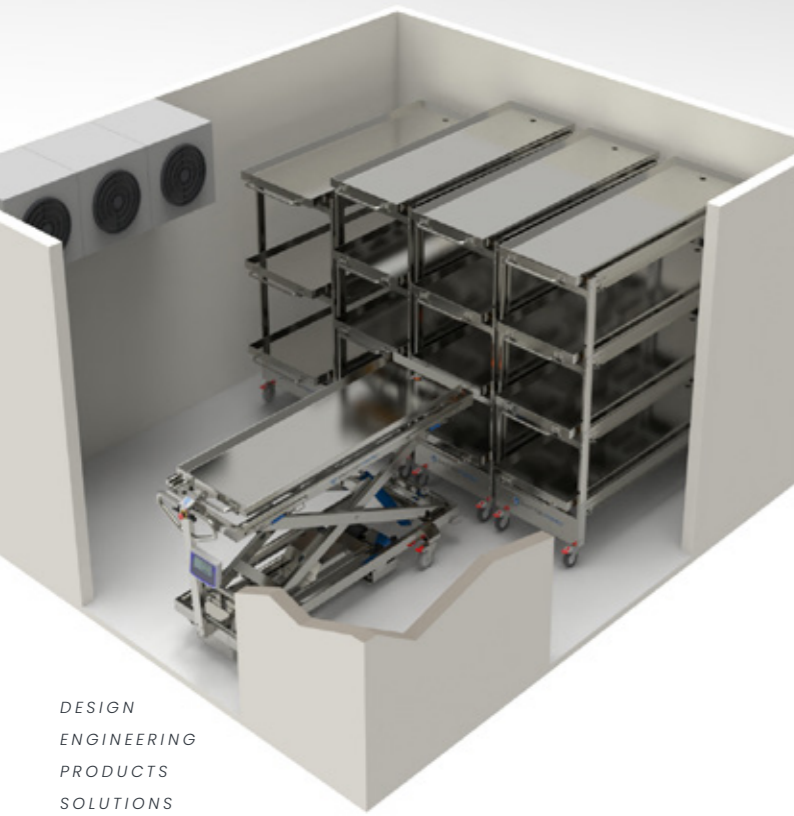

DESIGN
ENGINEERING
PRODUCTS
SOLUTIONS
CUSTOMISATIONS
SERVICE

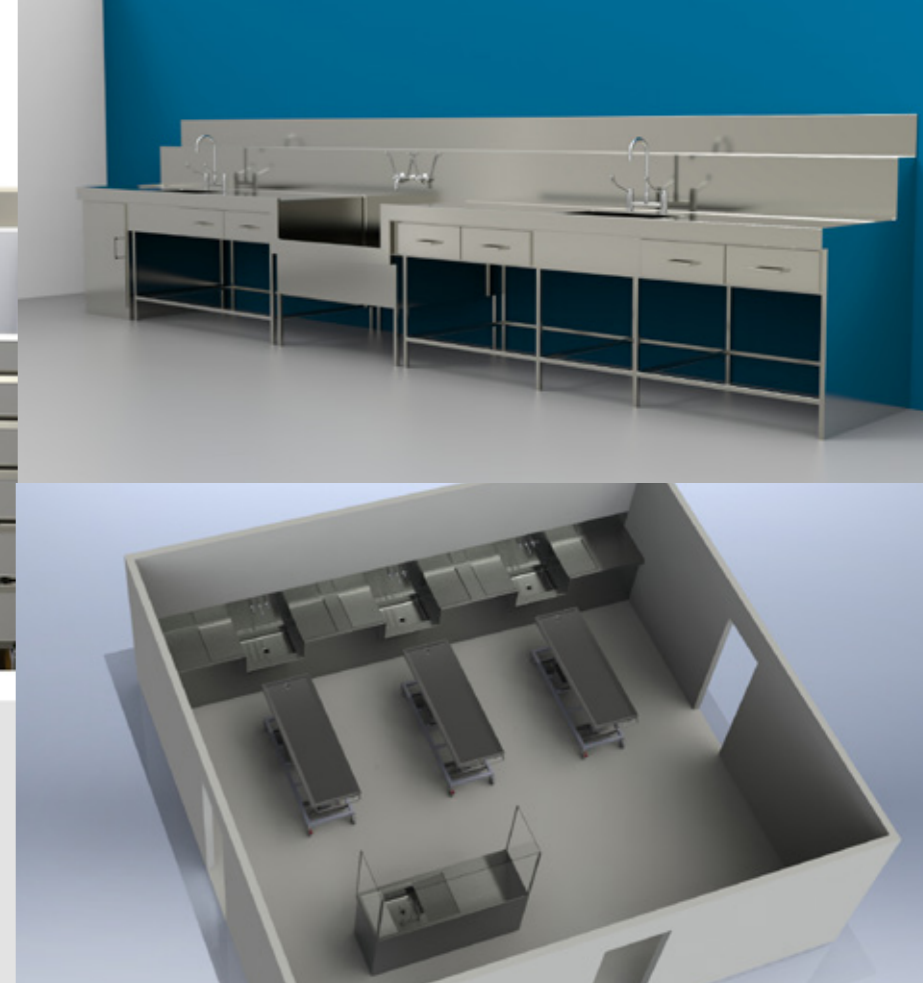
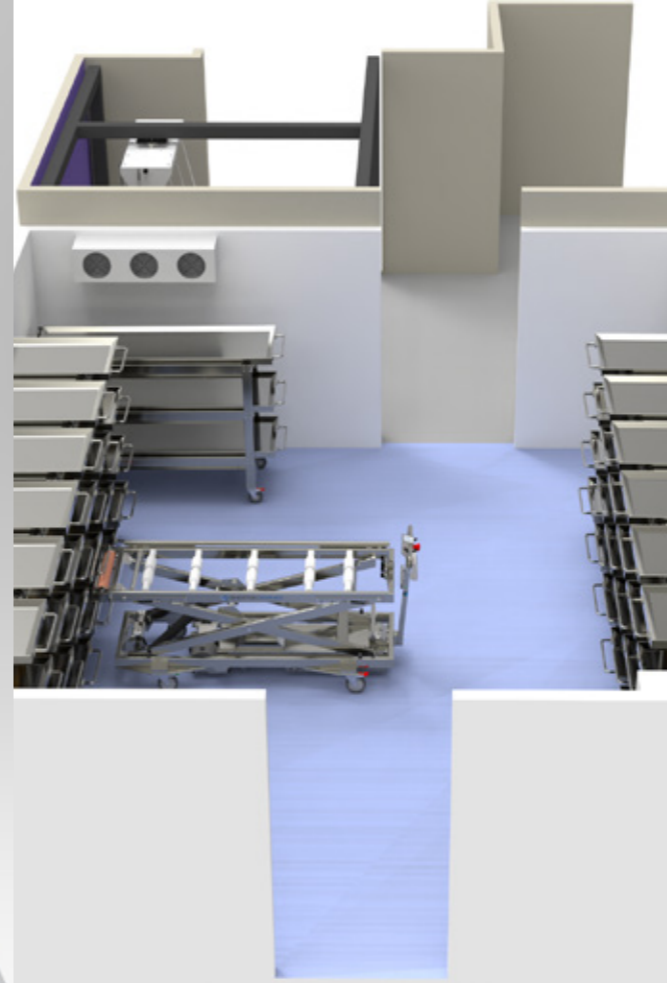

All photos are for product representation only. Product specifications are subject to change at anytime. Consult Shotton Parmed Sales for up to date product information

Concept to Reality - Facility fitout is one of Shotton Parmed's strengths, whether you're retrofitting or building a new facility, talk to us about how we can assist your project, we will provide a solution that works.



BEYOND INNOVATION

Shotton Parmed is a division of the Shotton Group Pty Ltd, a family business that is completely Australian owned. Shotton Parmed manufactures, supplies and services equipment for the autopsy, laboratory and mortuary markets. Our products and equipment are manufactured locally in our own facility in Dandenong South, Victoria with a small percentage of speciality goods imported from England.

Shotton Parmed's range of products include - down draft systems, autopsy tables, various types of benching, body trays, racking systems, lift and tilt trolleys and various other mortuary trolleys, mortuary body transport lifters, concealment systems, disaster recovery mortuary refrigeration and storage systems, Cuddle Cots and Cover Cools for excess cool storage solutions. We also offer tailored designs and bespoke solutions depending on customer requirements.

Our customers include Hospitals, Universities, Funeral homes and anywhere there are mortuaries or a need to care for the deceased.



CONTENTS

02	ABOUT US
04	ENGINEERING
06	HOSPITAL
08	RACKING
14	TRAYS
17	SPECIMENN TANK
18	TROLLEYS
24	LIFTERS
27	OVERHEAD HOIST
28	BENCHES
32	FUNERAL
34	VETERINARY
38	CONCEPTS
39	BODY BAGS
40	IMPORTED PRODUCTS
43	SERVICING & MAINTENNCE

SHOTTON ADVANTAGE

With over 40 years of experience in the industry, Shotton Parmed is not only an equipment manufacturer with a large range of products, we provide bespoke solutions ranging from full mortuary and cool room designs and fitouts to custom tailor made mortuary and laboratory equipment.

Consultancy Services

- Professional hazard and risk assessment assistance
- Work flow efficiency advice
- Free contemporary equipment or facility upgrade advice
- Bespoke design of equipment and whole facilities to solve most issues
- Equipment modifications and modernisation

Equipment Sales

- New contemporary equipment
- Used and re-furnished equipment as an efficient lower cost option
- Tailored engineering solutions

Equipment rental

- For times of capacity issues or break downs Parmed has a selection of equipment available to be rented for short or long term purposes

Visit our Showroom

- See the latest equipment available in the market today
- For free training on any of our equipment
- Test drive products before you buy
- Have a plant tour and meet the Parmed team, see the products being manufactured at our facility, talk to sales and engineering and feel comfortable you have received the best information and solution for your requirements



SHOTTON ENGINEERING ADVANTAGE

Backed by a full engineering team, Shotton Parmed delivers products and solutions to suit all needs from standard products to full bespoke projects

Enhance products to suit your requirements

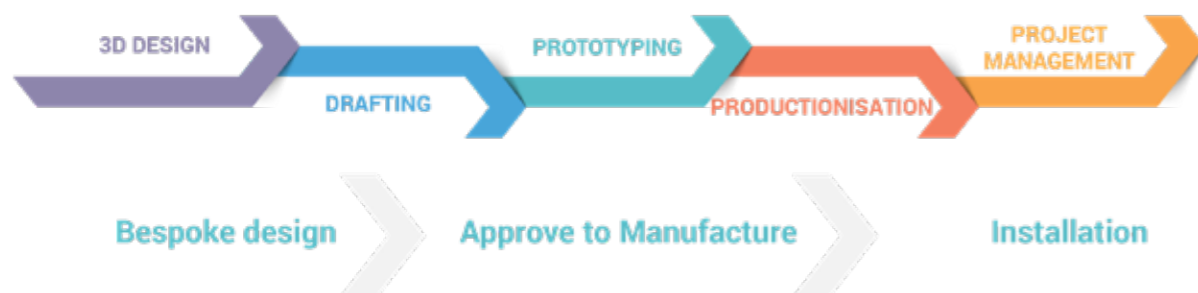

PARMED ONE TRAY SYSTEM



NO MANUAL HANDLING

Store and easily transfer bodies from racks to trolleys, PM stations, embalming and even viewing rooms and back to racks on one tray



WORK SMARTER

The body remains on the same tray throughout all procedures in the institution, with transfer to and from the autopsy/viewing/embalming station affected simply and quickly using a Lifter trolley. If it is a case of retrieval from the ward, the Lifter is often sent up to the ward with an empty tray on to which the Body is transferred.

HISTORY

The One-Tray system was first implemented by Hencicare (now Shotton Parmed) in Australia over 35 years ago with the intention of eliminating as much effort involved as possible, with manual Body Transfer across work surfaces. This concept has been in use at many institutions all over Australia, but primarily in Forensic centres.



PRINCIPLE

The key principle behind the One-Tray system is the Body tray. This tray is designed, not only to store the Body, but also provide a stable work platform for procedures performed on the same body, including autopsies, dissection and embalming. The tray has features built in that optimises fluid drainage, and also access to the body.

SAFETY

The ParMED One-Tray System is purpose designed to eliminate debilitating physical effort, repeated body transfers, and unsafe handling using your body to exert force to lift, lower, push and pull while transferring Bodies.

WARD TRANSFER TROLLEY



Trays sold separately

The Ward Transfer Trolley was designed to accommodate travel between hospital wards and their mortuary for deceased patients. The trolley can be operated as a self propelled unit for longer travel or be used manually for close manoeuvring and short distance travel.

MATERIAL	304 Stainless Steel
HEIGHT RANGE	650mm - 1050mm (excluding tray)
WIDTH	890mm (750mm wide fixed tray)
LENGTH	2350mm
CAPACITY	320KG
POWER	240V

STANDARD FEATURES

- 4 x Lockable 200mm DIA Castors
- Traction Drive (self propulsion forward and reverse)
- Rechargeable battery
- Concealment Cover System

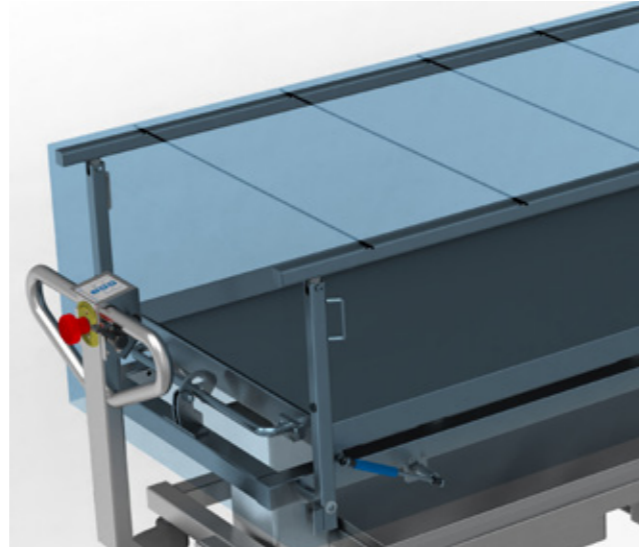

Transparent image of Concealment Cover System

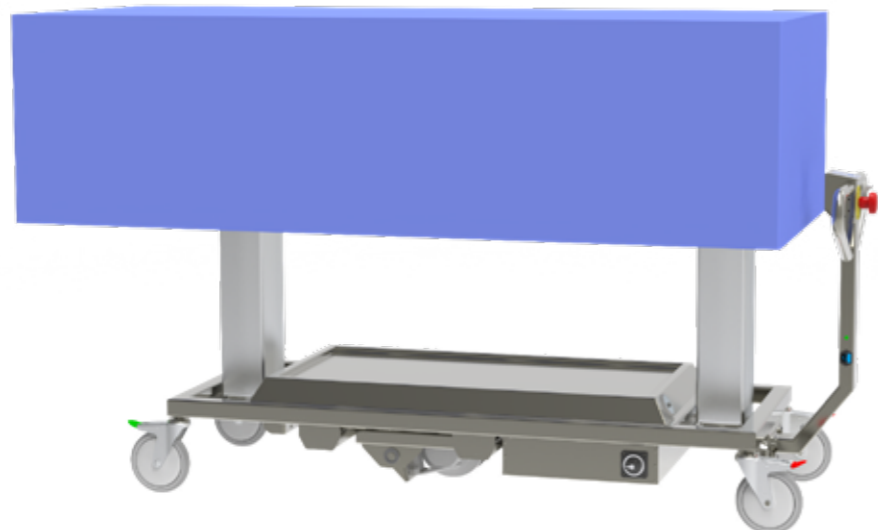

Trolley shown with erected Concealment Cover

HELICOPTER TRANSFER TROLLEY



The Helicopter Transfer Trolley was designed to travel between a helipad and hospital operating theatres. The trolley can be operated as a self propelled unit for longer travel or be used manually for close manoeuvring and short distance travel.

The trolley has provision for two oxygen bottles, multiple IV poles and underside storage.



Trolley shown with collapsed side rail

MATERIAL	304 Stainless Steel
HEIGHT RANGE	460mm - 860mm
WIDTH	890mm
LENGTH	2350mm
CAPACITY	320KG
POWER	240V

STANDARD FEATURES

- 4 x Lockable Castors
- Traction Drive (self propulsion forward and reverse)
- Rechargeable battery
- Collapsible side rails, with underneath retraction
- Removable end rails
- Storage tray
- Two oxygen bottle holders
- IV pole
- Corner bumpers

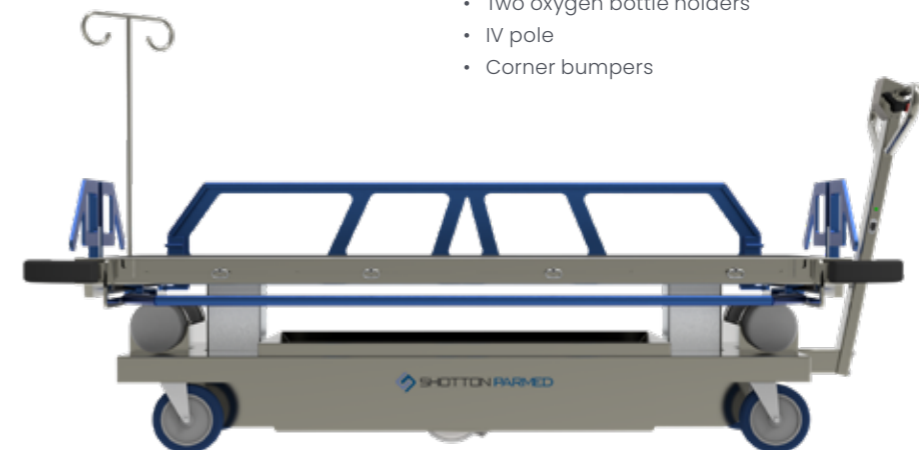

3 TIER BARIATIC STATIC & MOBILE RACKS



Our three tier static/mobile bariatic racks have been designed to fit into smaller cool rooms that are often found in funeral homes. Each tier can take 450kg making the trolley a perfect solution for immediate bariatic storage in all cool rooms. Locking wheels give the trolley stability while loaded and when unlocked makes it easy to be relocated when necessary. This system caters for almost all trays and coffins in the market so in most cases will be compatible with your existing products. The rubber coated locking front roller also secures your trays and coffins while stored.

MATERIAL	304 Stainless Steel
HEIGHT	1720mm
WIDTH	840mm (suits 750mm wide trays)
LENGTH	1900mm
CAPACITY	500KG / Bay (1 Tonne Max / Trolley)

- OPTIONS**
- Various heights and widths available
 - Adjustable front legs
 - Trolley to Trolley Locking clamps
 - 4 Tier

STANDARD FEATURES

- 4 x Lockable Castors
- Full Length rollers suitable for various trays and coffins
- Lockable Non-Slip Front roller

4 TIER STATIC & MOBILE RACKS



Our four tier static/mobile bariatic racks have been designed to fit into smaller cool rooms that are often found in funeral homes. Each tier can take 250kg making the trolley a perfect solution for immediate storage in all cool rooms. Locking wheels give the trolley stability while loaded and when unlocked makes it easy to be relocated when necessary. This system caters for almost all trays and coffins in the market so in most cases will be compatible with your existing products. The rubber coated locking front roller also secures your trays and coffins while stored.

MATERIAL	304 Stainless Steel
HEIGHT	1950mm
WIDTH	770mm (suits 660mm wide trays)
LENGTH	1900mm
CAPACITY	250KG / Bay (1 Tonne Max / Trolley)

- OPTIONS**
- Various heights and widths available
 - Adjustable front legs
 - Trolley to Trolley Locking clamps
 - Bariatic upgrade to 450kg / bay

STANDARD FEATURES

- 4 x Lockable Castors
- Full Length rollers suitable for various trays and coffins
- Lockable Non-Slip Front roller

RACKING

RACKING



3 TIER SIDELOAD STATIC RACK



Our three tier static Sideload racks have been designed to fit into smaller cool rooms that are often found in funeral homes where front loading racking cannot be used. Each tier can take 250kg making the rack a perfect solution for immediate storage in all cool rooms. This system caters to sideloading 660mm and 750mm wide trays. The snub nose rollers allow for easier maintenance and cleaning when required.

MATERIAL	304 Stainless Steel
HEIGHT	1720mm
WIDTH	840mm (suits 660mm wide trays)
LENGTH	1900mm
CAPACITY	250KG / Bay (750KG Max)

- OPTIONS**
- Various heights and widths available
 - Height adjustable legs
 - Trolley to Trolley Locking clamps
 - 4 Tier

STANDARD FEATURES

- 4 x Lockable Castors
- Full Length rollers suitable for various trays and coffins
- Lockable Non-Slip Front roller

4 TIER ACACIA MOBILE RACK



Our four tier Acacia mobile racks has been designed to our entry level racking system. Each tier can take 200kg making the trolley a perfect solution for immediate storage in all cool rooms. Locking wheels give the trolley stability while loaded and when unlocked makes it easy to be relocated when necessary. This system caters for almost all trays in the market so in most cases will be compatible with your existing products.

MATERIAL	304 Stainless Steel
HEIGHT	1950mm
WIDTH	770mm (suits 660mm wide trays)
LENGTH	1900mm
CAPACITY	200KG / Bay (800KG Max)

- OPTIONS**
- Various heights and widths available
 - Trolley to Trolley Locking clamps
 - Bariatric upgrade to 450kg / bay

STANDARD FEATURES

- 4 x Lockable Castors
- Full Length rollers suitable for various trays and coffins
- Lockable Non-Slip Front roller



FIXED RACK - STUB NOSE ROLLER

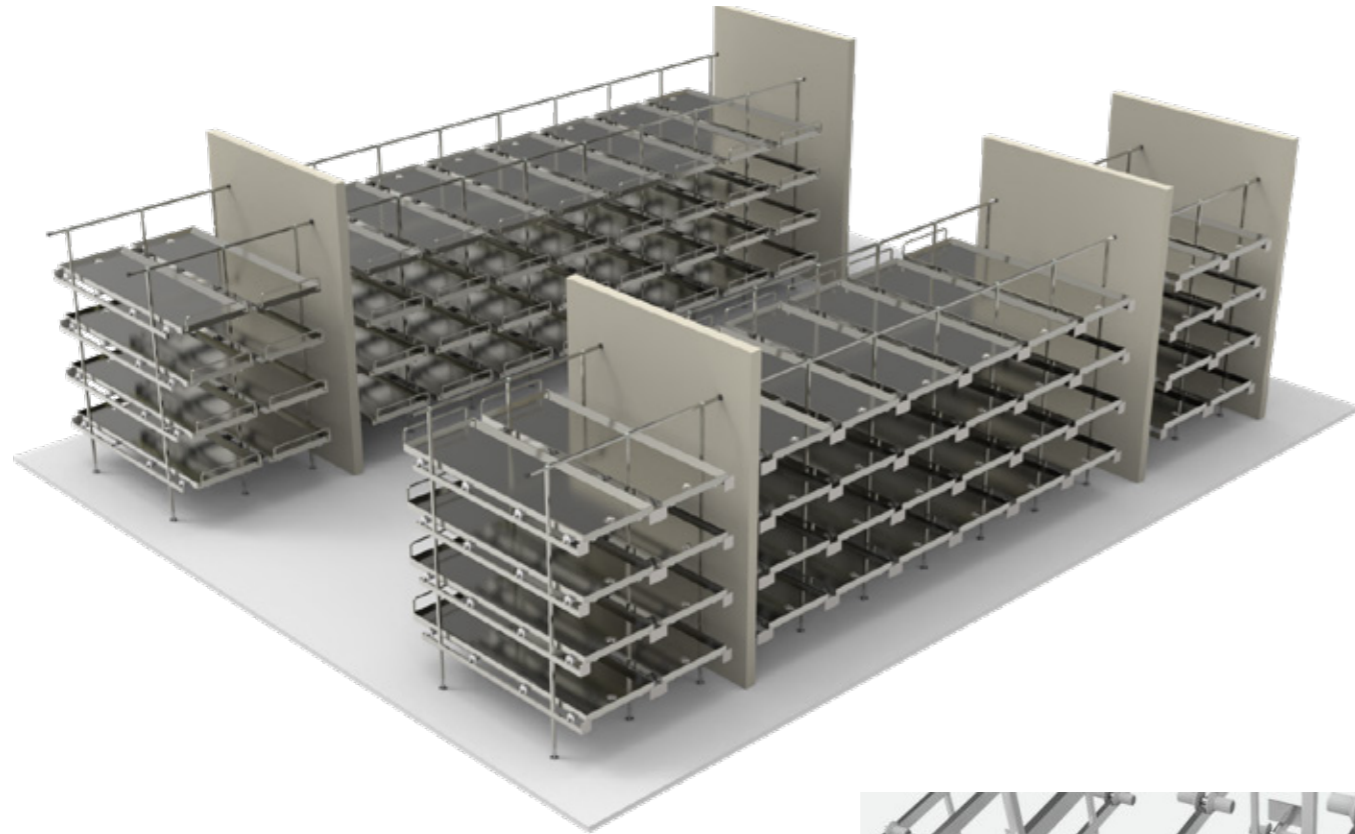

STANDARD FEATURES

- Stainless steel racks compatible with Shotton Parmed One Tray System
- Unique stub roller system - machined high density polyethylene rollers
- Designed to work with Shotton Parmed One Tray System & equipment
- Suitable to use in cool room environments
- Rack bays are modular design
- Rack designed to enable easy access for cleaning
- Racks bolted into floor and supported on stainless steel adjustable feet



Stub Nose rollers for walk through access

SPECIFICATIONS

MATERIAL Stainless steel No. 4 finish ASTM 316 (UNS S31600)
SIZE To client's specification (max 250 KGS)

OPTIONS

- Full Length Roller
- 450kg rating

CONTAINER RACKING



STANDARD FEATURES

- Riveted Assembly: Robust and reliable riveted construction method for enhanced strength and stability.
- Maximum Load Capacity: 250 kg per tier, allowing for a total of 750 kg per rack.
- Mechanical Tray Locks: Equipped with hook-type mechanical tray locks ensuring a reliable and secure storage solution.
- Height-Adjustable Feet: Allows for easy leveling and stability on uneven surfaces.
- ParMED Compatibility: Designed to integrate seamlessly with the ParMED one tray system.
- Galvanized Rollers: Integrated rollers for easy tray movement and support.

OPTIONS

- Aluminum Ramp

SPECIFICATIONS

FINISH Stainless Steel 304
RATING 750 KGS total
SIZE L 2050MM X W 740MM X H 1470MM
WEIGHT 100 KGS

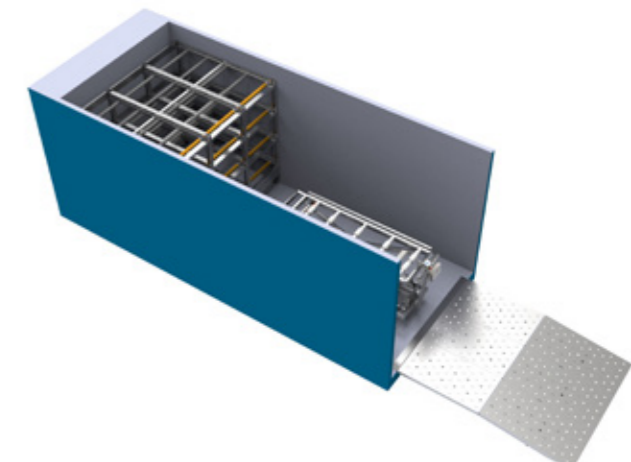
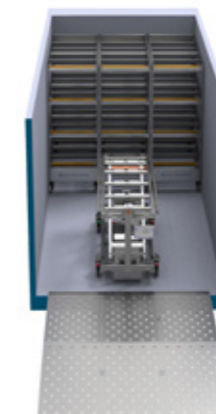
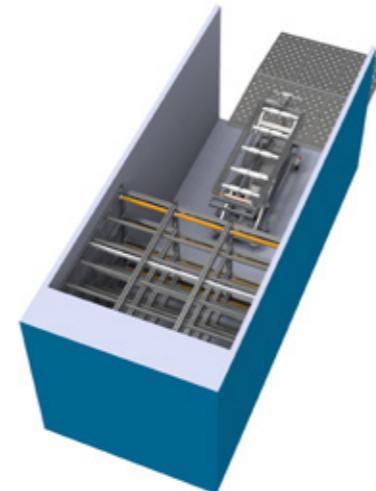
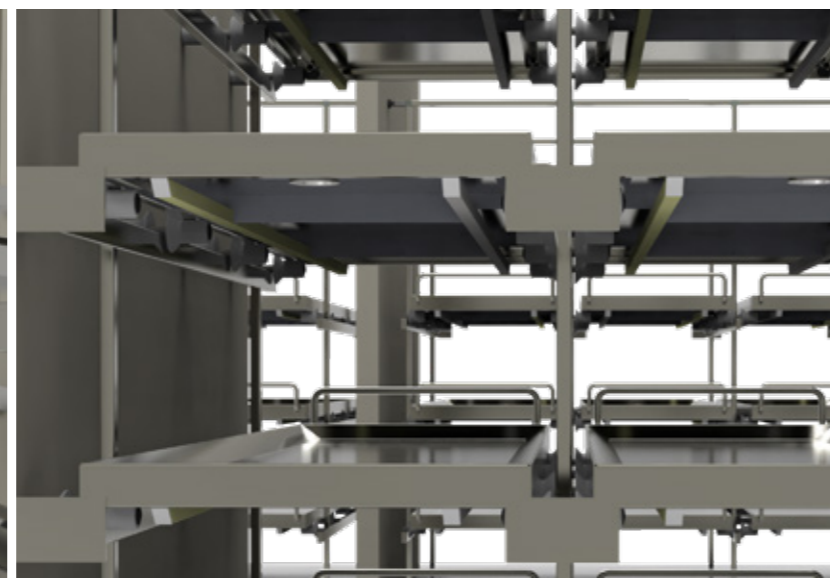

BANKSIA TRAY

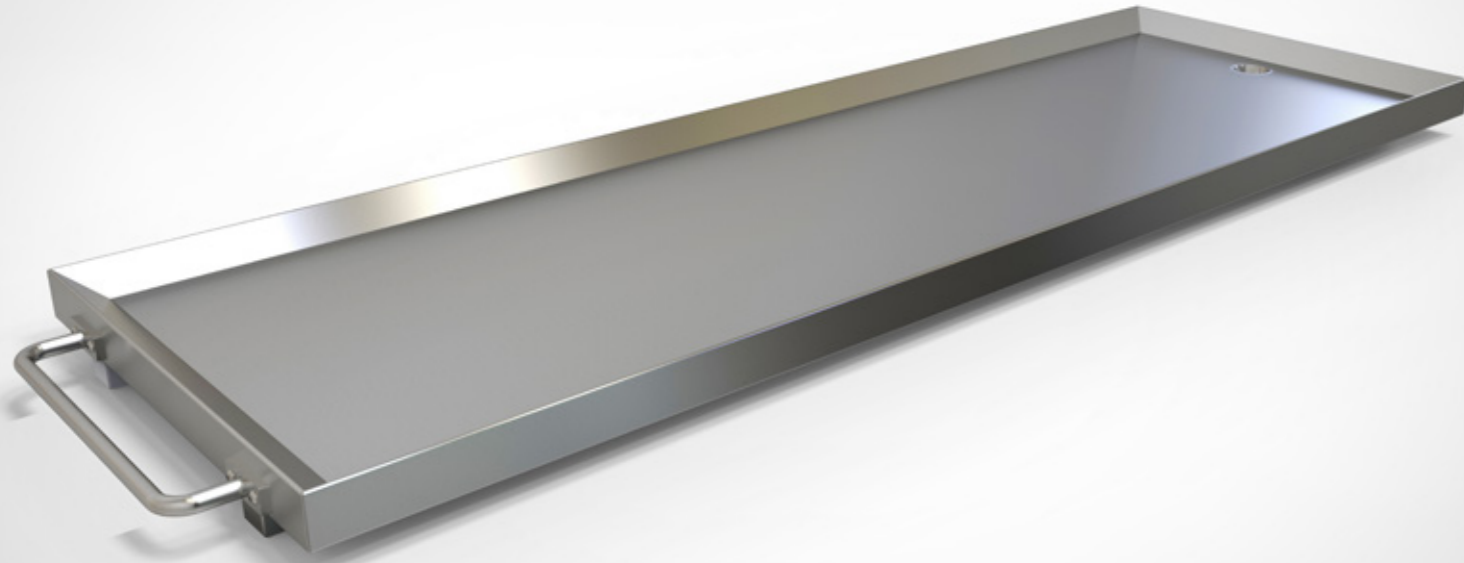

Internally welded corners

The NEW GENERATION TRAYS Parmed has designed now allow Parmed to offer different levels of trays with more competitive pricing structures that better suit all kinds of users from low to high volume. Our mid-level trays (Banksia Tray) are of a welded construction suitable for heavy processing use in Funeral homes, hospitals and universities.

MATERIAL	Stainless Steel
HEIGHT	32mm internal depth
WIDTH	660mm
LENGTH	2000mm (Excluding Handrail)

Internally welded corners

OPTIONS

- 304 S/S or 316 S/S
- ENDS: Welded & Ground
- Drain holes
- 750mm or 900mm width trays
- 1900mm tray length
- Tray Depth can be adjusted

FORENSIC TRAYS

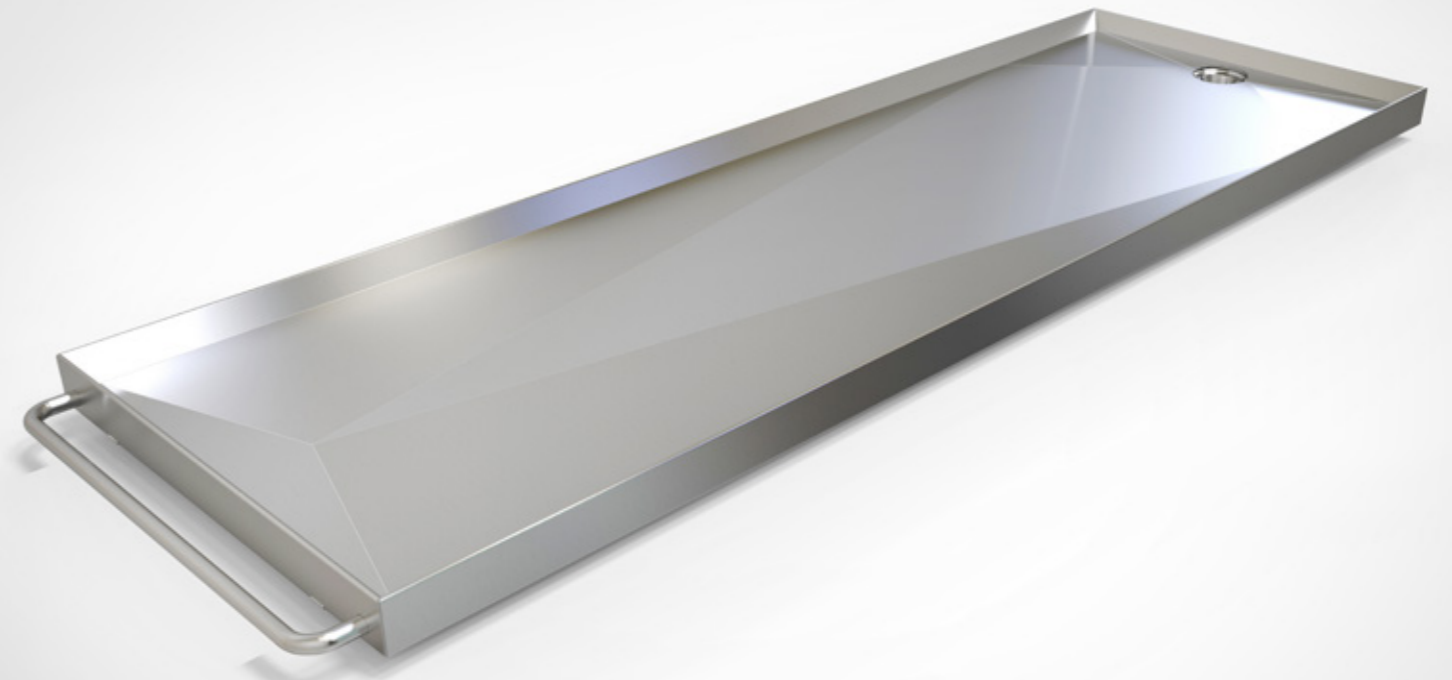

Fully welded and ground smooth to the highest level

The NEW GENERATION TRAYS Parmed has designed now allow Parmed to offer different levels of trays with more competitive pricing structures that better suit all kinds of users from low to high volume. Our top of the range trays (Forensic Tray) have been around for years and are suitable for Hospitals, Universities and Forensic environments.

660 WIDE BODY TRAY

- Stainless steel body tray
- Fully welded drain holes for easy drainage of fluids
- Deep folded sides to retain fluids within the tray
- Compatible with Parmed One Tray System
- Pressed ribs for torso support and fluid drainage
- Handle to one end of the tray
- Suitable to use in cool room environments
- All trays comply with standards set out in document PM200

SPECIFICATIONS

MATERIAL	S/S, ASTM 316 (UNS S31600) To external contact areas
SIZE	2050 l x 660 w x 85 h (mm)
FINISH	Stainless steel No. 4
LOAD RATING	250kg

OPTIONS

- 750 mm steel body tray 2000 l x 750 x x 85 h (mm)
- 450kg load rating
- Powder coating
- Alternative handle and drain options
- Width can be tailored



BANKSIA SIDE LOADING TRAY



Internally welded corners

The NEW GENERATION TRAYS Parmed has designed now allow Parmed to offer different levels of trays with more competitive pricing structures that better suit all kinds of users from low to high volume. Our mid-level trays (Banksia Tray) are of a welded construction suitable for heavy processing use in Funeral homes, hospitals and universities.

MATERIAL	Stainless Steel
HEIGHT	32mm internal depth
WIDTH	660mm (Excluding Handrail)
LENGTH	2000mm

OPTIONS

- 304 S/S or 316 S/S
- ENDS: Welded & Ground
- Drain holes
- 750mm or 900mm width trays
- 1900mm tray length
- Tray Depth can be adjusted

Internally welded corners



SPECIMEN TANK



STANDARD FEATURES

- Stainless steel 304 construction
- Controlled gas strut lid operation
- Rubber seal
- Load rated to 500 KGS
- 2000mm length
- 660mm width
- 338mm depth (sizes exclude handles)

OPTIONS

- Internal Frame and Basket system

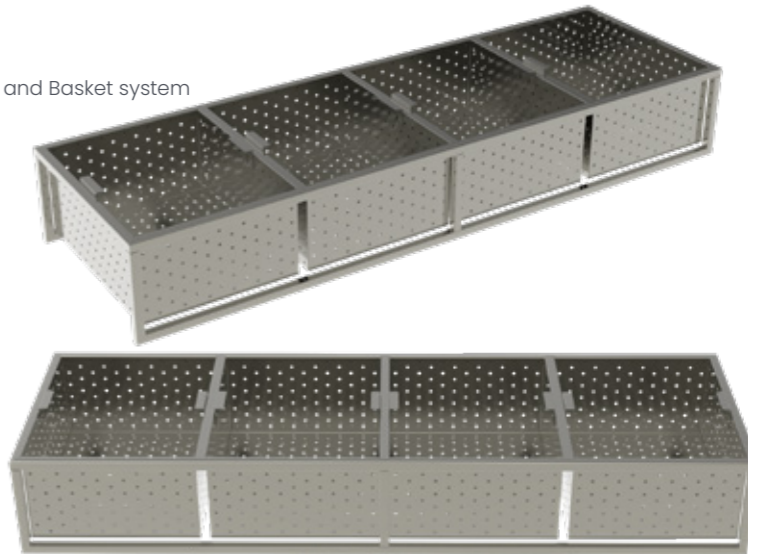

Specimen Tank shown with Frame and Basket System option

STANDARD MORTUARY TROLLEY



The standard mortuary trolley is constructed with 304 grade stainless steel, it is compatible with all Parmed trays and can be designed to suit other trays as well. Our trolleys have a mechanical tray lock system eliminating trays sliding of the trolley, it is load rated to 250kg, is easy to spray or wipe clean and also has 4 locking castors giving the trolley excellent stability during use.

MATERIAL: Stainless Steel
HEIGHT: 847mm
WIDTH: 657mm
LENGTH: 2049mm (Includes handle)

OPTIONS

- Various heights and widths available
- Adjustable front roller
- 450kg rating
- Drain bowl and bracket

STANDARD FEATURES

- Solid stainless steel construction (304 Grade)
- Full strength rollers suitable for various trays and coffins
- Locking castor wheels
- Tray lock mechanism



BARIATRIC MORTUARY TROLLEY



The standard mortuary trolley is constructed with 304 grade stainless steel, it is compatible with all Parmed trays and can be designed to suit other trays as well. Our trolleys have a mechanical tray lock system eliminating trays sliding of the trolley, it is load rated to 250kg, is easy to spray or wipe clean and also has 4 locking castors giving the trolley excellent stability during use.

MATERIAL: Stainless Steel
HEIGHT: 847mm
WIDTH: 657mm
LENGTH: 2049mm (Includes handle)

OPTIONS

- Various heights and widths available
- Adjustable front roller
- 450kg rating
- Drain bowl and bracket

STANDARD FEATURES

- Solid stainless steel construction (304 Grade)
- Full strength rollers suitable for various trays and coffins
- Locking castor wheels
- Tray lock mechanism



FIXED TRAY TROLLEY – MOBILE AUTOPSY TABLE



The standard fixed tray mortuary trolley is constructed with a 316 grade stainless steel tray top and 304 grade stainless for the frame, it is load rated to 250kg, is easy to spray or wipe clean and also has 4 locking castors that provide the trolley with operational stability during static use.

MATERIAL: Stainless Steel
LENGTH: 2000 mm
WIDTH: 660 mm
HEIGHT: 850 mm

OPTIONS

- Various heights and widths available
- Adjustable front roller
- 450kg rating
- Drain bowl and bracket

STANDARD FEATURES

- Solid stainless steel construction (316 grade top, 304 grade frame)
- 4 x Locking castor wheels

HEIGHT ADJUSTABLE TROLLEYS



CE Certified

NOTE: Trays sold separately

The Height Adjustable Tilt Trolley uses electrical operated columns and actuators as the lifting and tilting mechanism. This eliminates hydraulic fluids or oils and provides a quiet, steady lift force. A high duty cycle, rechargeable battery supplies the power and a push button controller makes operating the Tilt Trolleys effortless.

MATERIAL: 304 Stainless Steel
HEIGHT: 1400mm
WIDTH: 600mm
LOAD RATED: 350kg

OPTIONS

- Various heights and widths available
- Roller type
- Lateral tilt
- Automated shoulder adjustment
- Drainage bowl

STANDARD FEATURES

- Solid stainless steel construction (304 Grade)
- Full strength rollers suitable for various trays and coffins
- Front roller lock
- Mechanical tray lock

Optional shoulder adjustment trolley feature shown

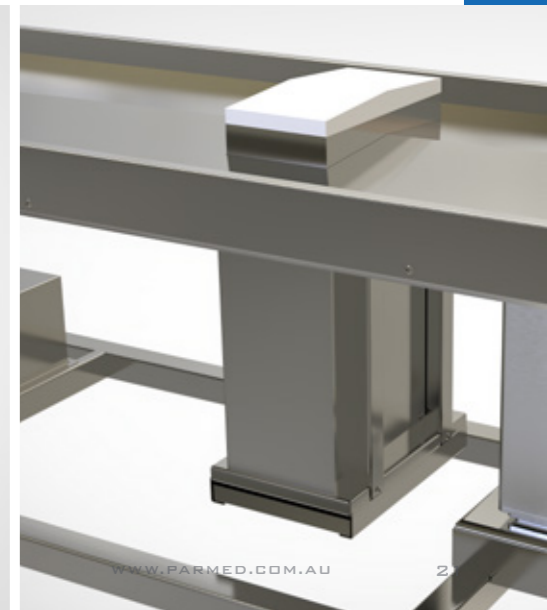
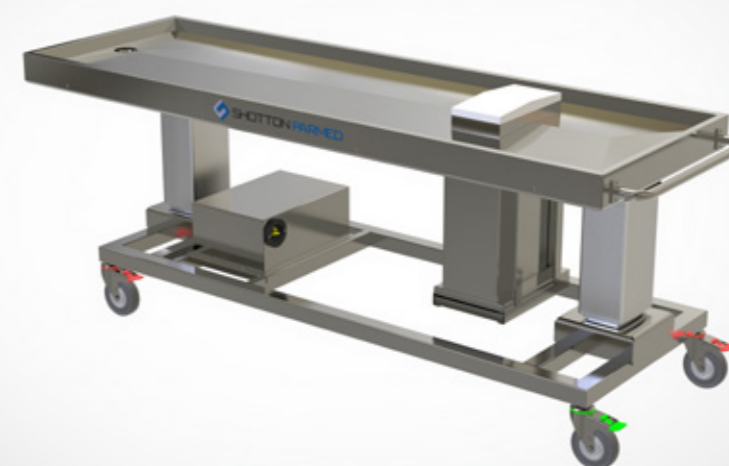

HEIGHT ADJUSTABLE LATERAL TILT TROLLEY



CE Certified

Optional lateral tilt and drainage bowl shown

NOTE: Trays sold separately

The Height Adjustable Lateral Tilt Trolley uses electrical operated columns and actuators as the lifting and tilting mechanism. This eliminates hydraulic fluids or oils and provides a quiet, steady lift force. A high duty cycle, rechargeable battery supplies the power and a push button controller makes operating the Tilt Trolleys effortless.

MATERIAL: 304 Stainless Steel
HEIGHT: 1400mm
WIDTH: 600mm
LOAD RATED: 350kg

OPTIONS

- Various heights and widths available
- Roller type
- Drainage bowl

STANDARD FEATURES

- Solid stainless steel construction (304 Grade)
- Full strength rollers suitable for various trays and coffins
- Front roller lock
- Mechanical tray lock

DOWN DRAFT TROLLEY



Dual door version shown

NOTE: Trays sold separately

CE Certified

Our Down Draft TROLLEY does exactly what it says, any fumes are drawn down into the trolley through perforated vents surrounding the tray and away from the user rather than into the air for a wall mounted extraction system to deal with. The table has two height adjustable columns that enable the user to lift, lower, and tilt the table front to back. It is fully compatible with the Parmed One Tray System, but can be built to suit any tray. Mount the unit to an external exhaust system and you are in action.

MATERIAL: 316 S/S Top & 304 S/S base
HEIGHT RANGE: 400mm of travel
WIDTH: 770mm
LENGTH: 2150mm

OPTIONS

- Tray
- Various heights and widths available
- Adaptable to any kind of tray
- Modular Benching
- Bariatric 400kg

STANDARD FEATURES

- Rechargeable Battery pack C/W charger
- Air Flow 210 L/s
- Automated lift & tilt (Inclination 0-17 Degrees)
- Load Rating 250kg

TROLLEYS

TROLLEYS

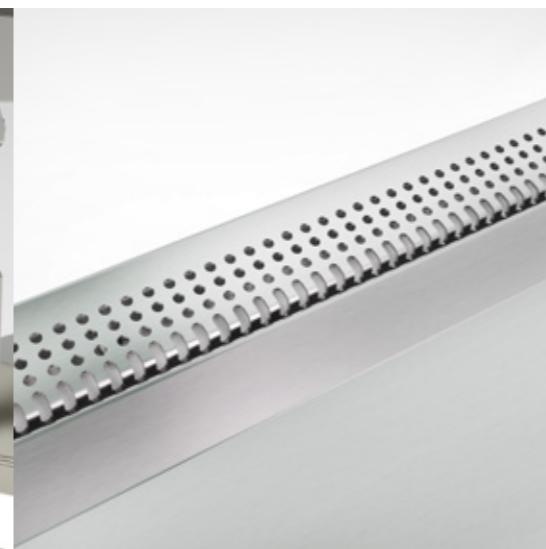
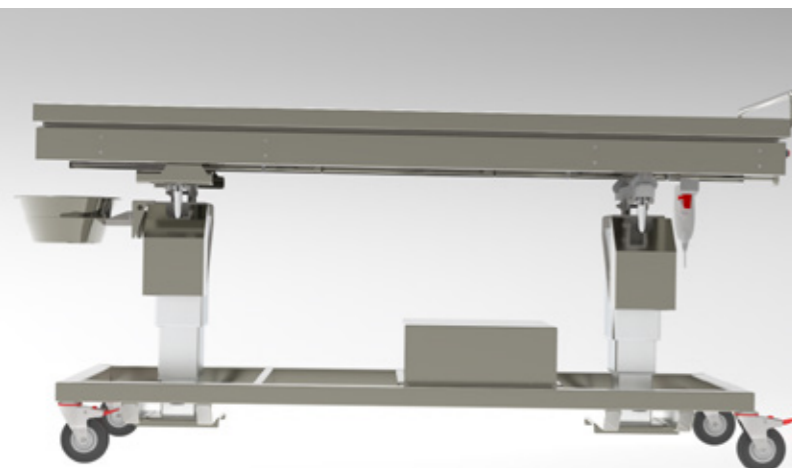

Standard single door version shown

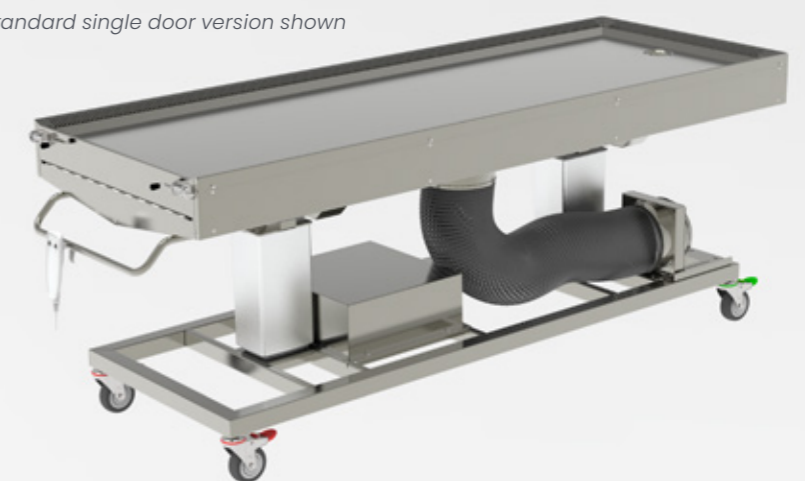

ACACIA LIFTER 180/250



250kg version shown

Featuring a basic yet effective modular design, the Acacia lifter series provides a stable platform which is easy to move and handle. Built to sustain years of continual heavy use and with a quality stainless steel finish, this lifter will look professional for years to come. Featuring a 24v rechargeable battery system and twin actuators, the Acacia Lifter has class leading lifting capabilities in its segment. Its key benefits, apart from the durable and aesthetic build quality, are the amount of options available and the way they can be upgraded at any time during the life of the lifter. This means it can be purchased at a very low cost with minimal options and upgraded when funding becomes available or as your mortuary grows. You don't have to buy a new lifter to upgrade the features, just order the upgrade you want and it can be retrofitted. It will reduce an immediate outlay and long term costs within your mortuary making this a useful, versatile and indispensable tool.

MATERIAL	304 Stainless Steel
HEIGHT	min 400mm max 1900mm
WIDTH	820mm
LENGTH	2167mm / 2373mm including handle
CAPACITY	180/250kg Plus Tray
LIFT SYSTEM	Electric

- Suits Parmed One Tray System
- Integrated Tray Lock
- Options Prepared (Upgradeable at any time)

OPTIONS: All able to be retrofitted

- Electric Over Hydraulic (upgradeable)
- 250kg capacity upgrade
- Traction drive (Self Propelling) suitable for carpet
- Tray retract (Automated tray loading and unloading)
- Integrated Weigh Scales
- Concealment cover; top and base options
- Adapt top to suit any tray
- Side handles & various handrail combinations

Side Load version shown



BANKSIA LIFT 300



CE Certified

Optional concealment cover frame shown in down position

Featuring a clever yet simple modular construction, the Banksia lifter provides a efficient platform that is easy to move and handle. Built to sustain years of continual heavy use and with a quality stainless steel finish, this lifter will look professional for years to come. Featuring a 24v rechargeable battery system and twin actuators, the Banksia Lifter has class leading lifting capabilities in its segment. Its key benefits, apart from the durable and aesthetic build quality, are the amount of options available and the way they can be upgraded at any time during the life of the lifter. This means it can be purchased at a very low cost with minimal options and upgraded when funding becomes available or as your mortuary grows. You don't have to buy a new lifter to upgrade the features, just order the upgrade you want and it can be retrofitted. It will reduce an immediate outlay and long term costs within your mortuary making this a useful, versatile and indispensable tool.

MATERIAL	304 Stainless Steel
HEIGHT	min 400mm max 1900mm
WIDTH	820mm
LENGTH	2167mm / 2373mm including handle
CAPACITY	300kg Plus Tray
LIFT SYSTEM	Electric

- Suits Parmed One Tray System
- Integrated Tray Lock
- Options Prepared (Upgradeable at any time)

OPTIONS: All able to be retrofitted

- Electric Over Hydraulic (upgradeable)
- 500kg capacity upgrade (Electric over hydraulic)
- Traction drive (Self Propelling) suitable for carpet
- Tray retract (Automated tray loading and unloading)
- Integrated Weigh Scales
- Concealment cover; top and base options
- Adapt top to suit any tray
- Side handles & various handrail combinations
- Side Loading

Shown lowered with fixed tray



Optional Side Load version shown



Optional concealment cover shown (transparent for representation only)



EUCALIFT 500 MODULAR LIFTER (ELECTRIC OVER HYDRAULIC)



CE Certified

Optional concealment cover frame shown in down position

Featuring an advanced, yet simplistic modular construction, the Eucalift series lifter provides a dynamic platform for use under the most extreme bariatric situations. Suitably easy to move and handle especially when utilizing our traction drive system this lifter is built to sustain years of continual heavy use and with a quality stainless steel finish this lifter will look professional for years to come. The lifter features a 12v rechargeable battery System and comes with an electric over Hydraulic lifting system. Its key benefits apart from the durable and aesthetic build quality is the amount of options available and the way it can be upgraded at any time during the life of the lifter. This means it can be purchased at a very low cost with minimal options and upgraded when funding becomes available or as your mortuary grows. You don't have to buy a new lifter to upgrade the features, just order the upgrade you want and it can be retrofitted at any time. In other words, it will reduce an immediate outlay and long term costs within your mortuary making this a useful, versatile and indispensable tool.

MATERIAL	304 Stainless Steel
HEIGHT	min 400mm max 1900mm
WIDTH	820mm
LENGTH	2167mm / 2373mm to Handle
CAPACITY	500kg Plus Tray
LIFT SYSTEM	Electric over Hydraulic

- Suits Parmed One Tray System
- Integrated Tray Lock
- Options Prepared (Upgradeable at any time)

OPTIONS

- Traction drive (Self Propelling) suitable for carpet
- Tray retract (Automated tray loading and unloading)
- Integrated Weigh Scales
- Concealment cover; Top and base options
- Adapt top to suit any tray
- Tray Locking Mechanisms (Suit different trays and coffins)

Optional concealment cover shown



Optional concealment cover shown (transparent for representation only)



OVERHEAD HOIST - PREMIER 500



CE Certified



Mobile Gantry option



SPECIFICATIONS

FINISH	WHITE POWDER COAT
RATING	500 KGS
OPERATION	PENDANT CONTROLLER
POWER	240V, 10 AMP
SIZE	L 1300MM X W 465MM X H 225MM
LIFT RANGE	2500MM MAX
WEIGHT	95 KGS

OPTIONS

- Rubber End Stops
- Ceiling Support Bracket
- 9060 Monorail
- Weigh Scale Indicator & Load Cell
- Track Suspension Trolley
- Swivel Unit
- Flat Cable Trolley
- Fixed Cable Trolley
- Down Lights (4 Watts LED)
- Mobile Gantry

STANDARD FEATURES

- Main Overhead Hoist unit
- Straps with stainless steel D rings, snap hooks and webbing buckles
- Nylon lifting slings
- Head strap with stainless steel buckles
- Pendant controller
- Power lead

SPREADER BAR - 500KG



STANDARD FEATURES

- Solid mild steel construction
- Powder coated finish
- Compatible to sling arrangement



Spreader Bar shown with sling arrangement

ACACIA BENCH



Shown with optional front splash guard

Featuring a clever yet simple modular construction, our bench system provides a stable easy to use economically priced platform that is built tough to sustain years of continual use and with a quality stainless steel finish will look professional for years to come. The system is based around a central sink docking station that has various standard sized optional side benches, cabinets, draw systems and shelving. Its key benefits apart from the durable and aesthetic build quality is the amount of options available and the way it can be configured to give the user the exact features and system they want and on top of that it can also be added to from our extensive range of options that are designed to just fit into place at any stage of its life. This means it can be initially purchased at a more economical cost with minimal options and upgraded when funding becomes available or as your mortuary grows. Potentially this system could reduce the size of the initial investment and long term costs within your mortuary making this a useful, versatile and indispensable tool.

MATERIAL	304 Stainless Steel
BENCH HEIGHT	900 mm
BENCH DEPTH	750 mm
LENGTH	Various

OPTIONS

- Customised Height
- 316 S/S
- Side Benches (500mm, 1000mm & 1500mm)
- Splashback height
- Single and double door Cabinet combinations
- Draw Systems and Front Splash Guards
- Tapware
- Welded or bolted together (depending on budget)
- Equipment Locking Mechanisms
- Installation

MORTUARY EMBALMING TABLE WITH SINK



Constructed from 304 Stainless Steel materials, Parmed's Mortuary Embalming Table provides an easy to use economically priced, alternative platform for general, autopsy or anatomy based usage. Built to sustain years of continual use and with a quality 304 stainless steel finish will look professional for years to come.

The Table is based around a less complex system that has the capacity to hold a body without the use of a body tray for operations. Complete with a basic sink, tapware and plumbing fittings can be supplied as optional extras, the table also comes with height adjustable feet to help with the installation.

MATERIAL	304 Stainless Steel
BENCH HEIGHT	900 mm
BENCH DEPTH	660 mm
LENGTH	2400 mm
CAPACITY	350KG

OPTIONS

- 316 S/S Top
- Splashback
- Tapware
- Drain and plumbing fittings
- Installation

Corner Bench version shown



Optional benches of various sizes available



BANKSIA BENCH

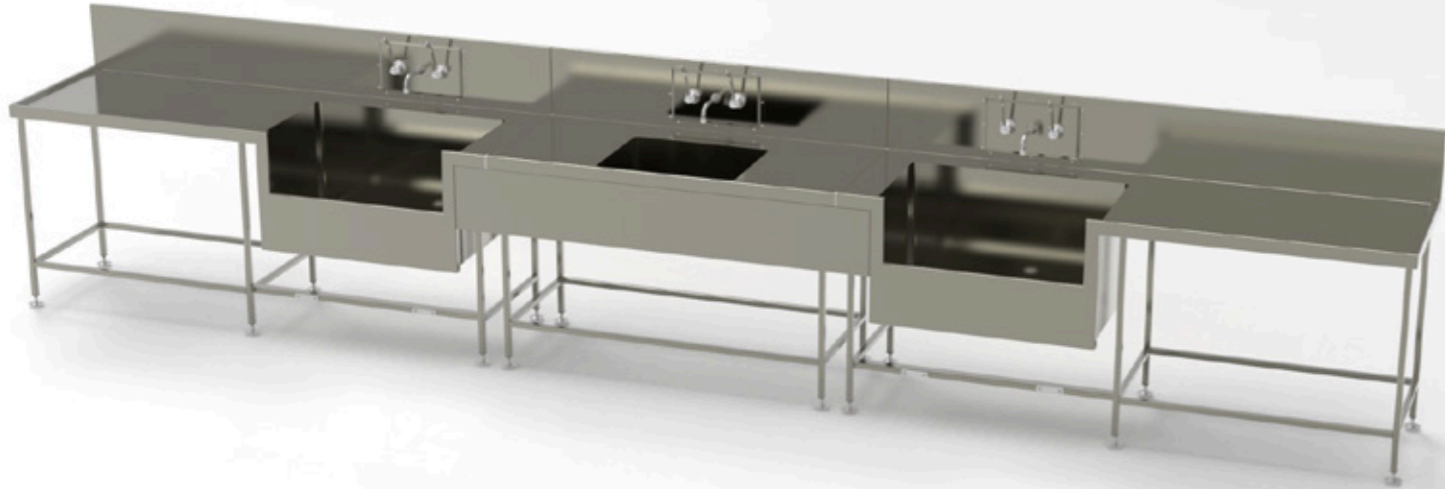

Bench length shown is 6 metres

Featuring a clever yet simple modular construction, our bench system provides a stable easy to use economically priced platform that is built tough to sustain years of continual use and with a quality stainless steel finish will look professional for years to come. The system is based around a central sink docking station that has various standard sized optional side benches, cabinets, draw systems and shelving. Its key benefits apart from the durable and aesthetic build quality is the amount of options available and the way it can be configured to give the user the exact features and system they want and on top of that it can also be added to from our extensive range of options that are designed to just fit into place at any stage of its life. This means it can be initially purchased at a more economical cost with minimal options and upgraded when funding becomes available or as your mortuary grows. Potentially this system could reduce the size of the initial investment and long term costs within your mortuary making this a useful, versatile and indispensable tool.

MATERIAL	304 Stainless Steel
BENCH HEIGHT	900 mm
BENCH DEPTH	750 mm
LENGTH	Various

- OPTIONS**
- Customised Height
 - 316 S/S
 - Side Benches (500mm, 1000mm & 1500mm)
 - Splashback height
 - Single and double door Cabinet combinations
 - Draw Systems
 - Tapware
 - Welded or bolted together (depending on budget)
 - Equipment Locking Mechanisms
 - Installation

Optional benching shown: various cupboards and shelving choices available



Optional benches of various sizes available



DOWN DRAFT BENCH

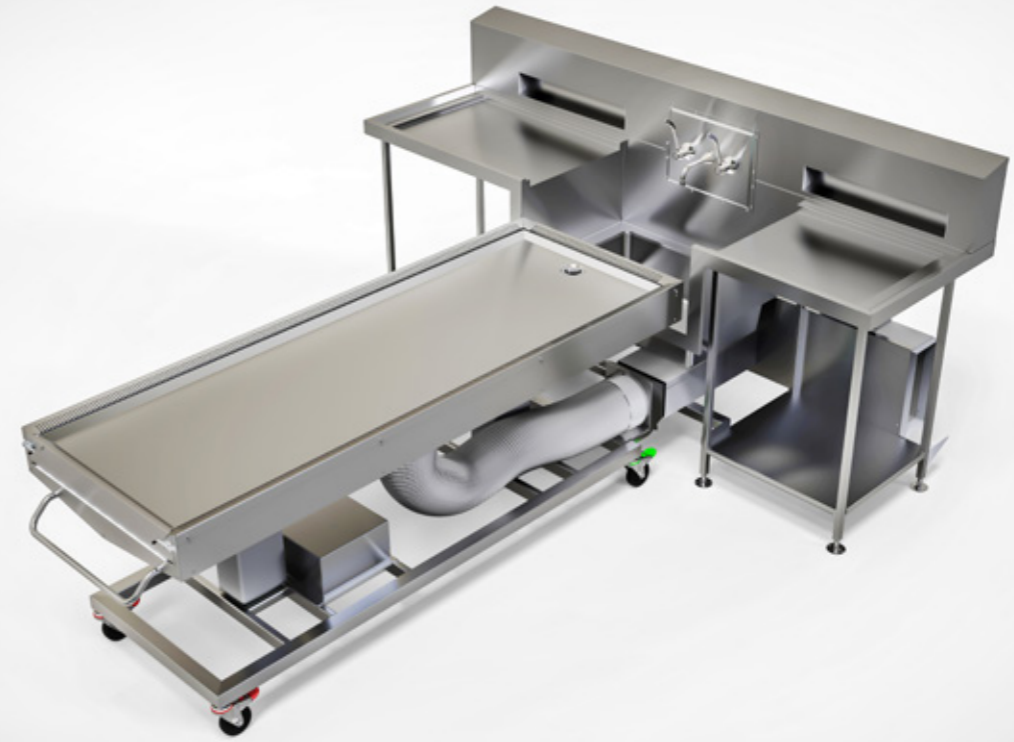

Down Draft Trolley not included with Down Draft Bench

Featuring a clever yet simple modular construction, our bench system provides a stable easy to use platform that is built tough to sustain years of continual use and with a quality stainless steel finish will look professional for years to come. The system is based around a central sink Down Draft docking station that has various standard sized optional side benches, cabinets, draw systems and shelving. Its key benefits apart from the durable and aesthetic build quality is the amount of options available and the way it can be configured to give the user the exact features and system they want and on top of that it can also be added to from our extensive range of options that are designed to just fit into place at any stage of its life. This means it can be initially purchased at a more economical cost with minimal options and upgraded when funding becomes available or as your mortuary grows. Potentially this system could reduce the size of the initial investment and long term costs within your mortuary making this a useful, versatile and indispensable tool.

MATERIAL	304 Stainless Steel
BENCH HEIGHT	900 mm
BENCH DEPTH	750 mm
LENGTH	Various

- OPTIONS**
- 316 S/S
 - Side Benches (500mm, 1000mm & 1500mm)
 - Splashback height
 - Single and double door Cabinet combinations
 - Draw Systems
 - Tapware
 - Welded or bolted joints (depending on budget)
 - Equipment Locking Mechanisms
 - Installation



CRYPT LIFTER



MATERIAL 304 stainless steel
HEIGHT Min 295 mm /Max 1514 mm
WIDTH 860 mm
LENGTH 1850 mm deck / 2014 mm inc handle
CAPACITY 300kg
LIFT SYSTEM Electric twin ram

STANDARD FEATURES

- Includes casket lock and locating pins
- Ball bearing top for easy coffin movement
- Emergency stop switch



CASKET TROLLEY



MATERIAL 304 Stainless Steel
SIZE L 1000mm x W 450mm x H 600mm
CAPACITY 250KG

STANDARD FEATURES

- Tubular stainless steel construction
- 3mm Anti slip neoprene on cross bars
- Two lockable castors
- Light weight
- No assembly required



CASKET DISPLAY RACKING



DESIGNED TO DISPLAY EMPTY CASKETS

Perfect solution for casket display in funeral homes with multiple tiers to show off different casket types.

MATERIAL 304 Stainless Steel
BENCH HEIGHT Available on request
BENCH DEPTH Available on request
LENGTH Available on request
CAPACITY 2 - 3 Casket versions available

STANDARD FEATURES

- Solid stainless steel construction
- 80 KG per tier
- Adjustable Feet
- Roll out base
- No assembly required



EXAMINATION TABLES

LARGE HEIGHT ADJUSTABLE TABLE



Optional bowl and bracket shown

The Height Adjustable Large Examination Table uses electrically operated columns for the lifting and tilting functions. This eliminates hydraulic fluids or oils and provides a quiet, steady lift force. A high duty cycle, rechargeable battery supplies the power and a push button pendant controller makes operating the table effortless.

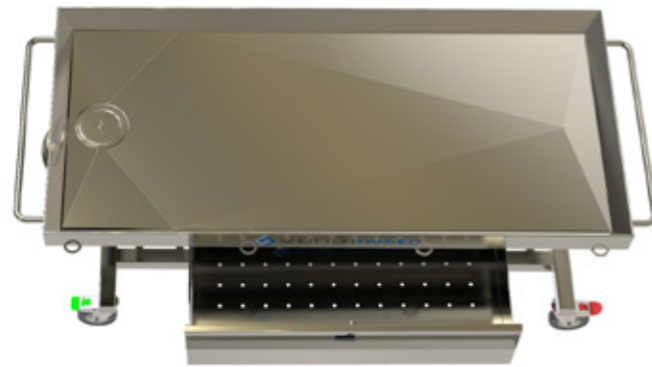

MATERIAL: 304 Stainless Steel
HEIGHT RANGE: 800 – 1200mm
TABLE SIZE: L 1400mm x W 600mm
LOAD RATED: 350kg
POWER: 240V

STANDARD FEATURES

- Solid stainless steel construction
- Full strength table tray
- Large storage drawer
- Pendant Controller
- Lockable castor wheels
- Drainage hole

OPTIONS

- Tray size variations available
- Lateral tilt
- Drainage bowl and bracket



EXAMINATION TABLES

SMALL HEIGHT ADJUSTABLE TABLE



Optional bowl and bracket shown

The Height Adjustable Small Examination Table uses an electrically operated column for the lifting functions. This eliminates hydraulic fluids or oils and provides a quiet, steady lift force. A high duty cycle, rechargeable battery supplies the power and a push button pendant controller makes operating the table easy and perfect for use with smaller animals.



MATERIAL: 304 Stainless Steel
HEIGHT RANGE: 800 – 1200mm
TABLE SIZE: L 1200mm x W 600mm
LOAD RATED: 150kg
POWER: 240V

STANDARD FEATURES

- Solid stainless steel construction
- Full strength table tray
- Pendant Controller
- Lockable castor wheels
- Drainage Hole

OPTIONS

- Tray size variations available
- Lateral tilt
- Drainage bowl and bracket



LIFTER TROLLEY



Extended full height shown



Closed lowered height shown

The Lifter Trolley uses an electronically operated system for its lifting function located on the underside of the tray. This eliminates hydraulic fluids or oils and provides a quiet, steady lift force. A rechargeable battery also located underneath the tray, supplies power and a push button pendant controller makes operating the lifter table, an effortless task.

MATERIAL: 304 Stainless Steel
HEIGHT RANGE: 320 – 850mm
TABLE SIZE: L 1100mm x W 660mm
LOAD RATED: 100kg
POWER: 240V

STANDARD FEATURES

- Solid stainless steel construction
- Full strength table tray with tie down points
- Pendant Controller
- Lockable castor wheels

ANIMAL BODY BAGS



Our Animal Body Bags are available in a range of sizes and offer a high level of leak protection when in use. Available in white as standard.

For further details, please contact us about sizing, colour options and availability.

Product images shown are representative only

TEACHING TROLLEY



Trolley shown with optional stools



Designed for the teaching environment, the trolley can easily accommodate upto 6 students for class activities. Equipped with a dual faced, reversible top, the trolley can be used for either practical or theory works.

MATERIAL: 304 Stainless Steel
HEIGHT: 847mm
TABLE SIZE: L 2049mm x W 657mm
LOAD RATED: 350kg
POWER: 240V

STANDARD FEATURES

- Solid stainless steel construction (304 Grade)
- Dual face table top A side flat, B side Recessed for specimens
- Drainage hole
- Lockable castor wheels

OPTIONS

- Customisable Heights and widths available
- 316 S/S
- 500KG increased capacity
- Splashback height
- Drain Bowl and bracket
- Stools

CONCEPT TO REALITY

THE SIMPLEST TO THE MOST COMPLEX

Shotton Parmed can offer the solution that you need, whether that may be a product outside of our standard range or a tailor designed facility, we can provide what you're after including concepts, full design, manufacturing and testing if required, all within Australia.

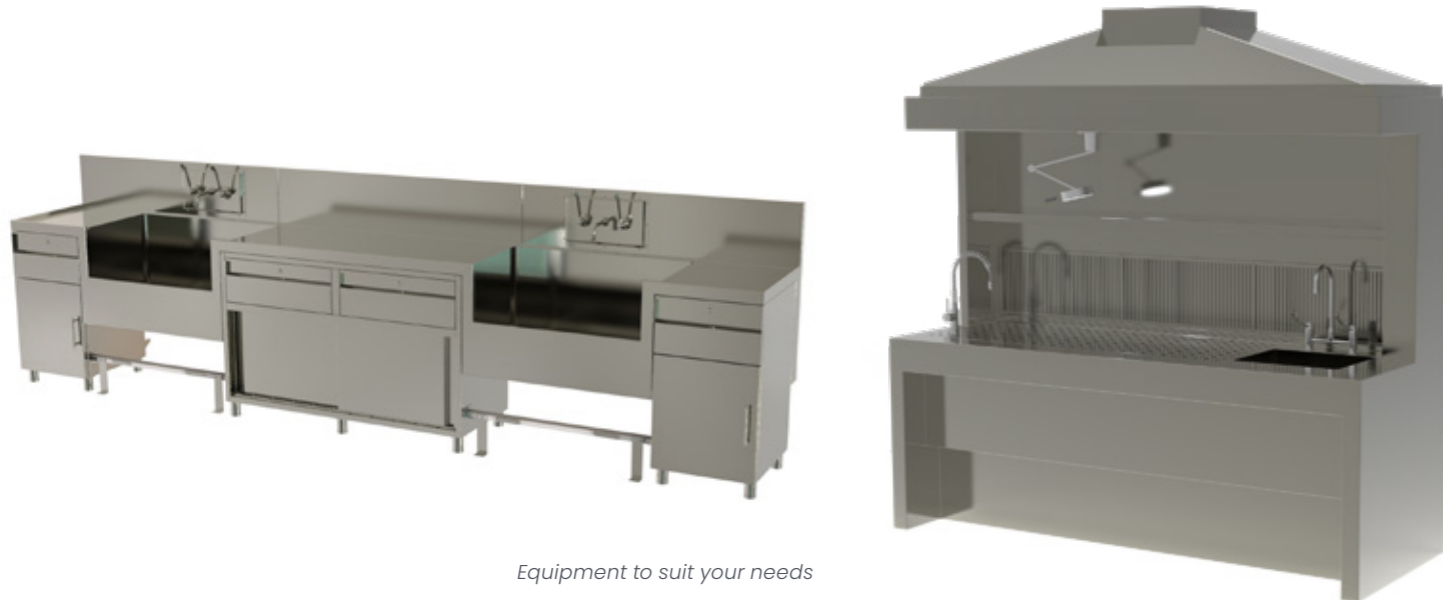

Equipment to suit your needs

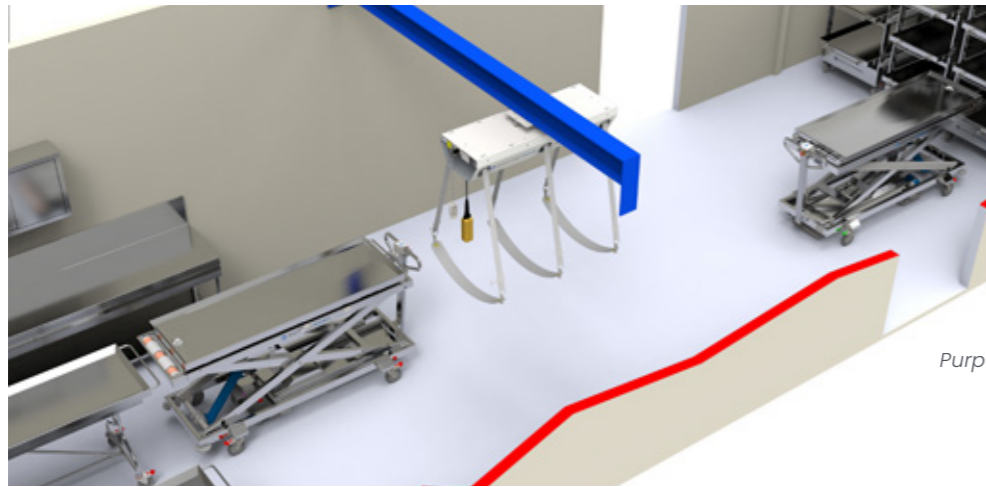

Purpose built facilities

Mass storage facilities

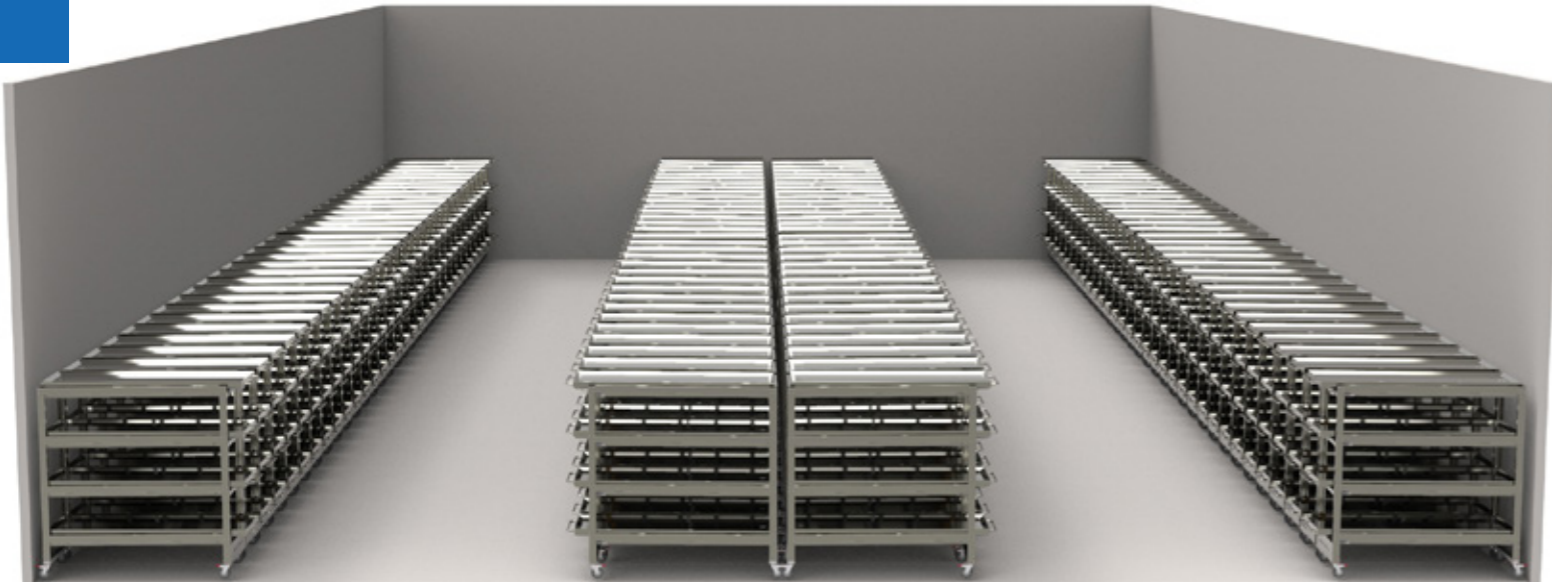

PARMED BODY BAGS



Product images shown are representative only

Our range of Body Bags are made using Quality Materials, Zippers, ID pockets as standard and come in a range of sizes and styles. D Shape Body Bags opens up flat or Top Zip can be an option too. They are made to order in a colour range and sizes from Bariatric, XXL, Adult, Teen, Child, Infant and Prem.

They are designed to contain fluids and prevent external leakage. We provide a range of Body Bags to our Emergency Services, Hospitals and businesses and can provide you with options to suit.

For further details, please contact us about sizing, colour options availability.

Sizing

- Adult XXL Body Bag – 2.45 X 1.8M
- Bariatric Body Bag – 2.45 X 1.2M
- Adult Body Bag- 2.45M X 90CM
- Teen Body Bag – 175 X 70CM
- Child Body Bag – 100 X 70CM
- Infant Body Bag – 75 X 50CM
- Prem Body Bag – 40 X 40CM

Options

- Body Bags are made within Australia using.
 - High Quality Material
 - D Shape or Top Zip Options
 - Quality Zipper
 - ID pocket
 - Webbing Handles Across ways/Length ways optional
 - Range of Colours & Sizes

COVERFLEX RECOVERY BODY BAGS



The CoverFlex Body Bags are made in Australia from high quality UV, tear and water-resistant material. Designed to transport deceased bodies in harsh environments and where movement and transport conditions are rough.

Standard

- Adult Size 2.45m x 90cm
- Raised Zip
- UV, tear and water-resistant material
- Absorbent liner
- Heat sealed ends
- Webbing handles – 3 x across ways and 2 x length ways
- Waterproof Zipper
- Valve
- Velcro ID pocket

Options

- Child Size also available
- Without valve
- Range of colours

CHEMICAL RESISTANT BODY BAGS

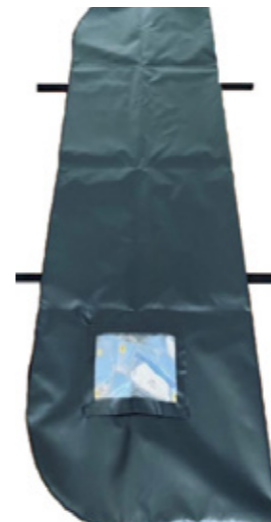

Superior quality Australian made, Chemical Resistant Body Bags to meet a range of needs for support workers in forensic, funeral and associated industries.

Standard

- Adult Size 2.45m x 90cm
- D-Shaped Top Zip
- UV, tear and water-resistant material
- Absorbent liner
- Webbing handles – 3 x across ways and 2 x length ways
- Waterproof Zipper
- Velcro ID pocket

Options

- Range of colours

PARMED IMPORTED PRODUCTS CuddleCot™

CuddleCot™ has been internationally recognised across the world as significantly helping parents who experience the loss of a baby. Dealing with the death of a baby is clearly an incredibly difficult event for parents and bereaved families should be given the option of spending Time with their baby. Providing families Time through the use of the CuddleCot is internationally encouraged by midwives, bereavement practitioners, still birth/neonatal charities, and academics. Time allows the family to form an important bond with their baby; whether changing a nappy, dressing the baby, taking photographs or simply just staying close and this unquestionably helps families in dealing with their loss. The baby's condition in a warm room can deteriorate quickly, therefore cooling a baby is essential with the use of a CuddleCot Unit. Transferring to and from the morgue is now widely regarded as an outdated practice as it is traumatic for parents to repeatedly go through the separation process whereas the CuddleCot allows the family to spend every moment with their baby, precious moments where every minute counts.



Features

- Small at just 27cm x 23cm x 13cms
- Light (control unit is 3.8kgs)
- Portable - comes in a storage case
- Flexible as can cool in any Shnuggle basket, moses basket, cot etc
- Whisper quiet

The Shnuggle Basket

The CuddleCot™ is designed to be used with the specially adapted Shnuggle™ basket which is provided exclusively by Flexmort. The baskets have been specially molded to accommodate the cooling pad and hose and provide hospitals with an easy to clean baskets thereby reducing any infection control issues.



The new CuddleCot™ carry case fits inside the Shnuggle™ moses basket making it easy to store or transport when not in use.



The CuddleCot™ system cools the baby in situ allowing the baby to remain with the family thereby providing the family time they want. The CuddleCot™ cooling pad is placed in a Shnuggle Basket, crib, pram or on a bed; it is connected by a specially insulated hose and is quietly cooled using the CuddleCot™ cooling unit. The CuddleCot™ system comes in its own carry case with different size cooling pads for premature and full term babies.

The benefits of using the CuddleCot™ system in helping a family deal with bereavement are widely accepted across the globe and the system is in worldwide use across maternity departments and children's hospices e.g United Kingdom, Australia, Canada and the US.

The CuddleCot has also passed rigorous hospital infection control standards on all aspects of the equipment and the CuddleCot is also designed to reduce the risks of microbial growth within the system.



PARMED IMPORTED PRODUCTS COVERCOOL (CUDDLE BLANKET)



Portable, Light, Flexible and Quiet.

CoverCool™ revolutionises cooling and allows you to cool and store bodies in a range of settings such as a home without the need for cold rooms, air conditioners or mortuary fridges. CoverCool™ consists of a small cooling unit which circulates fluid through a cooling pad which is placed either underneath or on top of the body.

Tested in University Medical facilities and used by hospices, funeral directors and hospitals, the CoverCool™ mobile cooling system can cool a deceased infant, child, or adult on a bed or in a coffin (as shown). The Covercool Unit comes with an insulated cover that can simply be placed over the deceased providing longer term single body storage. The mobile CoverCool™ cools the body without the need for traditional purpose built refrigeration or cold rooms. Furthermore, unlike refrigerated beds or coffin coolers it is extremely light, portable, flexible and quiet. Furthermore, unlike mortuary refrigerators, CoverCool is only switched on when required.

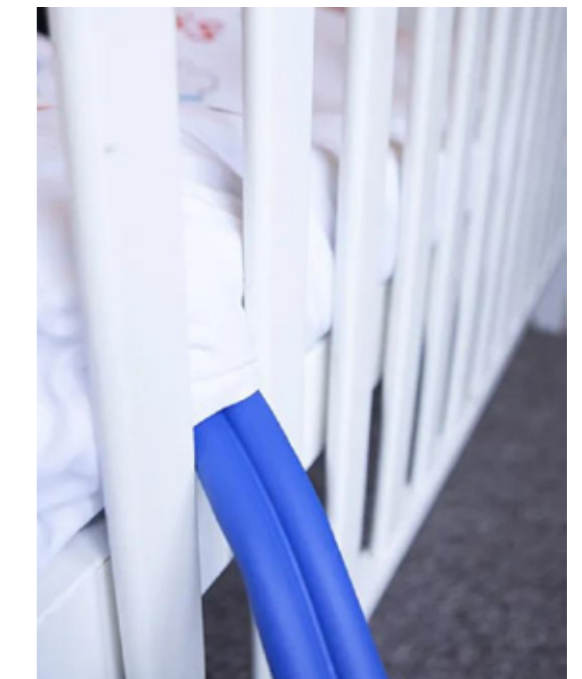

PARMED IMPORTED PRODUCTS

AIRCOOL 12

12 Body Storage

- Total unit dimensions (excluding air con unit) 2185mm x 1960mm x 2070mm depth
- Fully rolled racks – bodies can simply be easily slid into place using the body boards
- Racking rollers are equipped with stops at the end to prevent body boards getting pushed too far
- The bottom rack placed 40cm off the floor. This makes the system fully compatible with current body transportation trolleys.



Features

Lightweight insulation covers. Easy to assemble and carry:

- This insulation is the most thermally efficient insulation of its type in the world.
- All insulation covers are attached using Velcro. Zips have been eliminated due to 3 reasons:
 - Zips can fail and snag and if zips cannot be fastened then the unit would not efficiently cool bodies due to loss of insulation
 - If a stone gets caught in the hook and loop (Velcro) insulation covers then these covers can still fit together
 - Zips cannot be insulated and therefore lose heat thus they are thermally less efficient than Velcro
- 12 x A4 document clear wallets situated on the doors to enable documentation on the deceased to be stored easily
- Total weight - 367kg

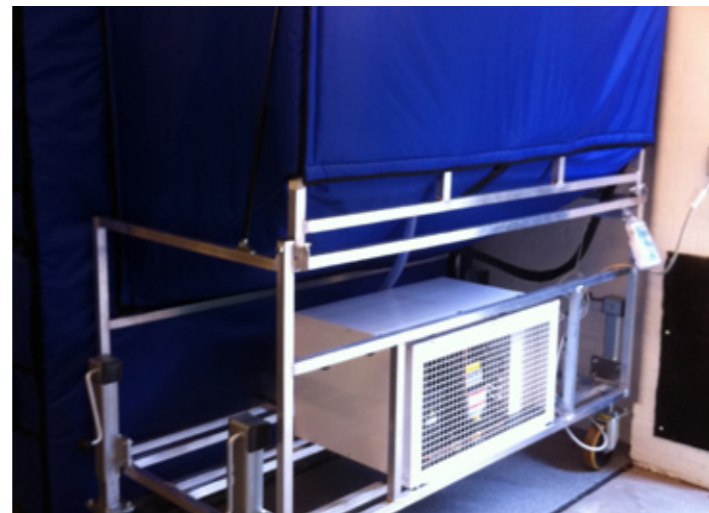

PARMED PREVENTATIVE MAINTENANCE AGREEMENT (PMA)

Your equipment is just like a car, it must be serviced to maintain any manufacturer's warranty on newly purchased equipment and also to ensure a duty of care for the ongoing safe operation for all users and stakeholders.



HAVE PEACE OF MIND

Shotton Parmed Service Maintenance Plans are designed to optimise serviceability and life of your plant and equipment.

The maintenance plans include a set number of service visits over a 12 month period which include an agreed and documented checklist of inspection and safety checks.

Service records are maintained with each visit and a report is issued at service completion with tasks log and recommended actions that may need attention beyond the scope of the agreement. A copy of the report is provided for equipment service/maintenance history.

Parmed Preventative Maintenance Agreement Service Intervals

We understand that every customer's needs are different and we tailor the frequency and level of service to suit your needs

One to five year Maintenance Agreements are available with visits timed to coincide with other Agreement clients within your area to minimise travel costs and ensure the most economical results for each and every client.

YOUR MORTUARY AND LABORATORY ARE SAFE WITH US

PEACE OF MIND

Tailored and customised maintenance agreements available to suit your needs.

PROTECT YOUR ASSETS

Achieve their maximum life usage and efficiency.

MEET YOUR WORK HEALTH & SAFETY OBLIGATIONS

BENEFITS OF PMA

- ▶ Reduce costs by identifying problems before inconvenient and costly breakdowns occur
- ▶ 10% Discount on parts, materials, labour and breakdown callouts
- ▶ 24 hr x 7 days Phone Support for technical troubleshooting and business hour repair bookings
- ▶ Improve plant and equipment safety and reliability on items within the agreement (Not just Parmed supplied products)
- ▶ 12 months extended Shotton Parmed (manufacturers) warranty on equipment if a service agreement is taken out during the first 12 months of ownership
- ▶ Expert knowledge and advice

OPTIONS

- ▶ Keep your team safe with Regular Testing and Tagging of electrical equipment and devices stated within the agreement
- ▶ Full load test of appropriate equipment to validate specified manufacturer load ratings are still achieved
- ▶ Tailored product training and competency evaluation programs developed for new and existing staff

CONTACT US FOR A FREE QUOTE

03 9791 6444

service@parmed.com.au

SHOTTON GROUP



Today, the company has 6 facilities in VIC and 1 in QLD totalling more than 7,500 m2

DISCLAIMER: Shotton Group Pty Ltd trading as Shotton Parmed offers this brochure as a general guide. Photographs and illustrations in this brochure are for illustrative purposes only and do not necessarily represent actual product models. All information and specifications contained in this brochure are based on the latest product information available at time of publication. Shotton Parmed reserves the right to make changes at any time, without notice in colours, materials, equipment, specifications, models & warranty. The specification and options stated in this brochure are for reference only. Colours may differ slightly from those shown in the brochure, owing to the limitations of the printing process.

NOTE: Specifications may change at any time without prior notice. Please consult Shotton Parmed Sales for up to date information on products. Products displayed in this brochure are available at the time of printing of this brochure. New products may replace the products in this brochure.

PRINTED: Q1 2023 Copyright: Shotton Group Pty Ltd T/A Shotton Parmed.

Main Office & Showroom

4 / 155 Greens Road Dandenong
South VIC 3175
Phone: 03 8725 1045

Email: sales@parmed.com.au
Email: service@parmed.com.au

SHOTTON PARMED

A division of Shotton Group Pty Ltd

www.parmed.com.au

45+ YEARS IN BUSINESS | WE BUILD TO LAST



PS 605209

Management
System
Certified to ISO 9001

